



Your partner in surgery
Accessories



A Sense of Company	5
A Sense of Care	7
SCHMITZ – worldwide	8
Control elements and basic equipment	12
General accessories	23
Accessories for orthopaedics, traumatology, spinal surgery and orthopaedic extension	36
Carbon Accessories	44
Extension device	46
Accessories for head positioning and neurosurgery	68
Accessories for Gynaecology and Urology	74
Positioning aids	82
Overview of accessories	90
Contact	95



A Sense of Company

With more than 90 years of experience, SCHMITZ is one of the leading international manufacturers of medical products.

A family-owned business with a living tradition. Our typical employee has been with the company for some 18 years, proof of how strongly they identify with our values and philosophy.

In 2012, the company's management passed to Friedrich and Matthias Schmitz, the fourth generation of the family.

We are proud to be located in Germany and are deeply rooted in our home region. We develop and manufacture here.

90% of our suppliers are from Germany, of which 60% are from the local region.

Made in Germany





A Sense of Care

We understand the services which are our lifeblood, and aim to achieve maximum customer satisfaction. From consulting through planning to installation.

Cost-effectiveness through longevity is what you can expect from us.

With a well thought-out service concept and comprehensive support, SCHMITZ works alongside you as partner from start to finish.

Technical Customer Service

T +49 (0)2377 84 549

service@schmitz-soehne.de

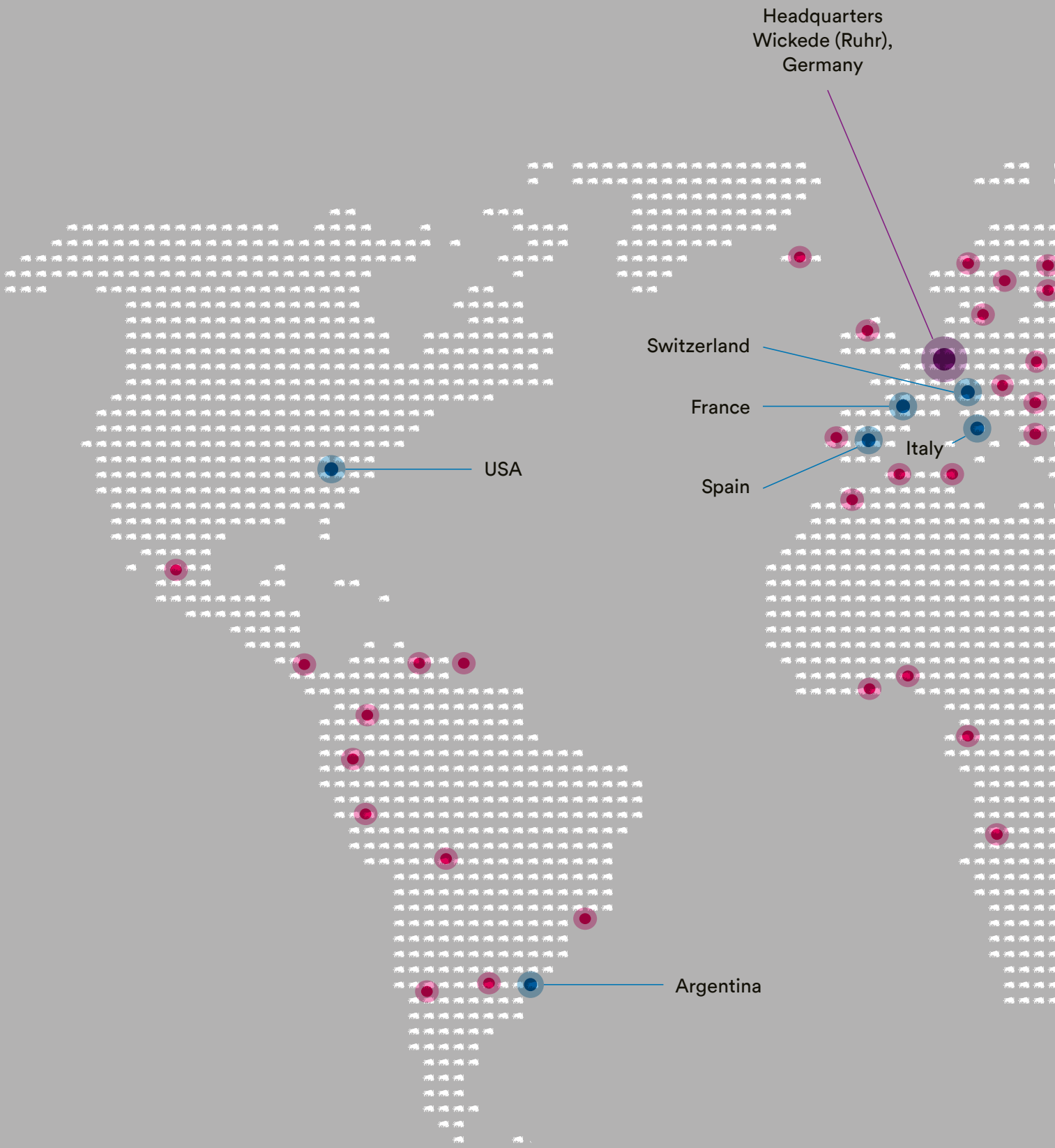

- Over 80 international trade partners
- Sales offices

SCHMITZ – represented worldwide





DIAMOND® and OPX mobilis® Accessories

Suitable accessories, easy to use

Quick and easy assembly of surgical accessories via the ports on the operating table, the coupling points at the foot and head end or via the side rail. Efficient support for quick and professional positioning.

Extensive selection of accessories

Suitable accessories for every position, whether gynaecological procedures in the lithotomy position or neurological surgery in the beach chair position. Position-specific accessories – developed together with users.



DIAMOND® CE^{MD}

Control elements

Model No. Description



101.0380.1 Hand control unit, cable-connected
plastic casing, sealed against ingress of fluids, cable-connected. Illuminated TFT display indicating all status information of the table. Backlit keyboard for all adjustment functions.
For DIAMOND® 50/60 models.

101.0590.1 Hand control unit, cable-connected
(w/o ill.) similar to 101.0380.1, but for DIAMOND® 40 models, without electrohydraulic leg section adjustment function.



101.0214.1 Hand control unit, Bluetooth®
plastic casing, sealed against ingress of fluids, wireless Bluetooth® connection. Illuminated TFT display indicating all status information of the table. Backlit keyboard for all adjustment functions. Requires Bluetooth® preparation 101.0391.1 and charging cradle 101.0356.0, 101.0357.0 or 101.0358.0!
For DIAMOND® 50/60 models.

101.0591.1 Hand control unit, Bluetooth®
(w/o ill.) similar to 101.0214.1, but for DIAMOND® 40 models, without electrohydraulic leg section adjustment function. Requires Bluetooth® preparation 101.0391.1 and charging cradle 101.0356.0, 101.0357.0 or 101.0358.0!



! Please provide an appropriate charging cradle for your Bluetooth® hand control!

We recommend to always have the table equipped with the Bluetooth® preparation in order to be able to profit from the advantages of the Bluetooth® system even at a later date.

The Bluetooth® control units for DIAMOND® 40 models are only available in conjunction with a cable-connected control unit! Please take this into account when placing your order.



Model No. Description

101.0206.1 Foot control, cable-connected

Cast aluminium casing, sealed against ingress of fluids, antiskid, cable-connected. For all table adjustment functions analogous to its hand-held control. Backlit TFT display for easy navigation, control panel illuminated by LEDs in the foot bar (for MIS). Activation key and “Return to zero” key. Can be connected to the table at the same time as the hand-held control unit. Requires preparation for foot control 101.0397.0. For DIAMOND® 50/60 models.

101.0359.0 Foot control, cable-connected

(w/o ill.) for DIAMOND® 40 models, similar to 101.0206.1, without electrohydraulic leg section adjustment function. Requires preparation for foot control 101.0397.0!

101.0397.0 Preparation for cable-connected foot control

(w/o ill.) Preparation of DIAMOND® operating table for use of a cable-connected foot control unit.



101.0216.1 Foot control, Bluetooth®

similar to 101.0206.1, however with wireless Bluetooth® connection. Incl. power supply unit for recharging the control unit. Requires Bluetooth® preparation 101.0391.1! For DIAMOND® 50/60 models.

101.0360.0 Foot control, Bluetooth®

(w/o ill.) for DIAMOND® 40 models, similar to 101.0216.1, however, without electrohydraulic leg section adjustment function

101.0391.1 Bluetooth® preparation

(w/o ill.) Preparation of DIAMOND® operating table for use of Bluetooth® hand and foot control unit.



DIAMOND® CE^{MD} Control elements

Model No. Description



101.0356.0 Charging cradle, pedestal version
pedestal version, charging cradle for inductive charging of Bluetooth® hand control unit, with LED status display, incl. mains adaptor. You can continue using the hand control while it is charging in the charging cradle



101.0357.0 Charging cradle, wall mount
same as charging cradle 101.0356.0, but wall-mounted version



101.0358.0 Charging cradle, side rail
same as charging cradle 101.0356.0, but version for attaching to side rail.



! Please provide an appropriate charging cradle for your Bluetooth® hand control!

DIAMOND®

Basic equipment

Model No. Description

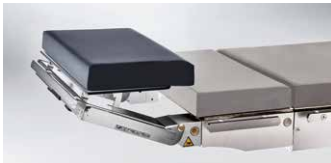

101.0017.2 Head plate
double-adjustment, automatic latching of pad inclination, integrated gas spring for weight compensation, detachable.

101.0480.0 Double table top
(w/o ill.) for X-ray cassette insertion, for head plate 101.0017.2.

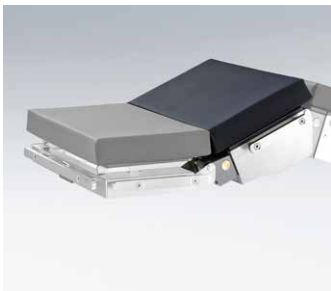

101.0159.0 Back section extension, inclinable
to be attached to the back section, for stretching patient's upper body in thoracic surgery and abdominal interventions, electromotive downward tilt up to 40°, length 300 mm including adapted pad for head section. Requires preparation for electr. adj. accessory 101.0238.0!

101.0238.0 Preparation for electr. adj. accessory
(w/o ill.) Preparation of DIAMOND® operating table for electrically adjustable accessory.

101.0580.0 Double table top
(w/o ill.) for X-ray cassette insertion, for back section extension, inclinable 101.0159.0.



101.0131.1 Back section extension, fixed
to be attached to the back section, length 280 mm.

101.0510.1 Double table top
(w/o ill.) for X-ray cassette insertion, for back section extension, fixed 101.0131.1.



Model No. Description

101.0689.0 Back section extension, short
to be attached to the back section, length 200 mm.

101.0690.0 Double table top
(w/o ill.) for X-ray cassette insertion, for back section extension, short 101.0689.0.

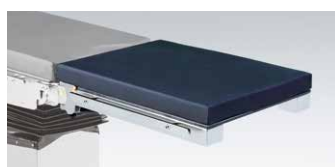

101.0145.2 Leg section
one-section type, manual folding
with gas spring assistance, detachable.

101.0490.0 Double table top
(w/o ill.) for X-ray cassette insertion, for leg section 101.0145.2.



101.0621.0 Leg section, light version
one-section type, reduced-weight design (7.3 kg),
w/o adjustment functions, viscoelastic foam mattress
with el. conductive cover, max. weight capacity 40 kg,
700 × 523 mm (L x W).



101.0116.2 Leg section
split type, fold-down, swivelling via latching
mechanism, sealed against fluids, integrated gas spring
for weight compensation, detachable, with carrying
handles. Optionally without gyn. cutout.

101.0500.0 Double table top
(w/o ill.) for X-ray cassette insertion, for leg sections 101.0116.2.





DIAMOND® CE^{MD}

Universal leg plate

Model No. Description

101.0572.0 Universal leg plate

Four-part leg plate, expands smoothly up to 72° on each side, can also be moved outwards, allows clearance of up to 360 mm for optimised access to operating area. Individually detachable lower leg plates each with separate expanding function up to 45° outwards, folding up to 90°, length adjusts smoothly from 756 mm to a total length of 900 mm. Removable leg plates with carrying handles.

The four-part leg plate from SCHMITZ at a glance:

- All features of a regular four-part leg plate
- Lower leg segments can be spread and removed and are adjustable in length
- Right and left side can be moved outwards in full length by 180 mm
- Maximum accessibility for the surgeon

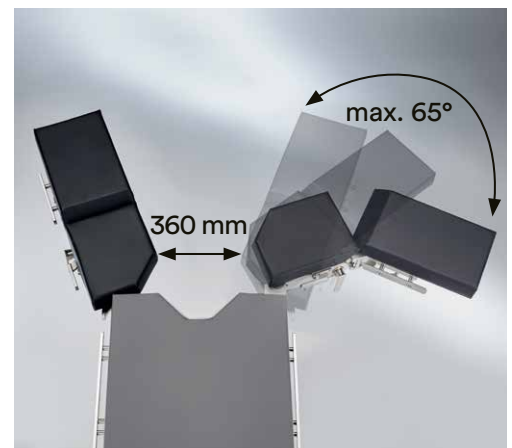
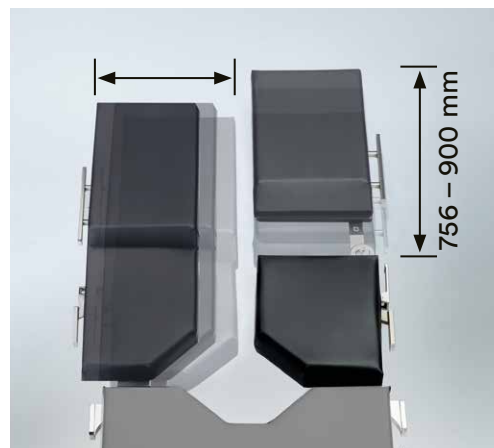



Model No. Description

101.0171.1 Leg section
four-part, front part foldable down to 155°,
swivelling via latching mechanism, detachable.

The SCHMITZ leg plate at a glance:

- A closed construction allows easy cleaning, thus meeting the highest demands of hygiene.
- A dual safety system for adjusting the leg plate prevents an accidental folding of the lower segment.
- The folding function can only be carried out after releasing the safety lever and triggering the safety handle.

Optionally without gyn. cutout.

101.0540.0 Double table top
(w/o ill.) for X-ray cassette insertion, for leg plates 101.0171.1.

OPX mobilis® CE^{MD}

Basic equipment

Model No.	Description
-----------	-------------

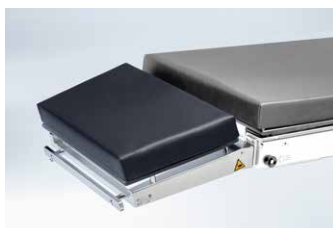

101.2580.1	Head rest servo-assisted one-hand tilting, detachable at the push of a button, with integrated X-ray cassette tunnel.
-------------------	---



101.2590.1	Head rest double-adjustment, servo-assisted weight compensation, detachable at the push of a button, with integrated X-ray cassette tunnel.
-------------------	---



101.2170.1	2 Section leg section manual swivelling and servo-assisted tilting with weight compensation, detachable at the push of a button.
-------------------	--



101.2180.1	Leg section one-piece version, servo-assisted tilting, detachable at the push of a button.
-------------------	--

General accessories

Model No.	Description
101.0192.0	Arm rest for an easy and quick positioning of the patient's arm in any position, adjustable in any direction by means of only one star handle, foam pad with antistatic cover, 450 mm long, with arm strap and attachment clamp, SST 18/10.
101.0019.0	Arm rest covered foam pad, antistatic, 450 mm long, with arm strap and attachment clamp, horizontally and vertically adjustable, tiltable via ball-and-socket joint, SST 18/10.
101.0109.1	Arm rest covered foam pad, antistatic, height adjustment range: 80 mm, one-touch swivelling through 360°, turning and tilting up to +/- 35°, incl. SST 18/10 clamp, 600 x 170 mm (W x D).



General accessories

Model No. Description



101.0252.0 Fastening strap
padded fastening strap for arm supports,
made of especially soft antistatic material
without sharp edges, 840 mm long, 50 mm wide.

101.0262.0 Fastening strap
padded fastening strap for immobilising
the legs on Göpel-type leg supports,
made of especially soft antistatic material
without sharp edges, 1,400 mm long.



101.0012.0 Anaesthetic frame
SST 18/10, with twist protection, height adjustable,
with swivelling clamp 101.0146.0.



101.0111.0 Anaesthetic frame extension
for anaesthetic frame 101.0012.0, swivelling and
laterally adjustable, length 300 mm.



101.0137.0 Wristlet
for attachment to anaesthetic frame 101.0012.0,
washable and exchangeable textile strap with
hook-and-loop fastener, SST 18/10 attachment.

Model No. Description



101.0125.0 Flexible anaesthetic frame*
2000 mm long,
2 attachment clamps 101.0146.0 required!



101.0164.0 Leg restraint strap
washable tissue strap with hook-and-loop fastener,
for leg fixation, for split leg sections.
Diameter of loop: 83 mm - 137 mm.

101.0625.0 Leg restraint strap
(w/o ill.) as 101.0164.0,
however, diameter of loop: 137 mm - 216 mm.



101.0123.0 Wristlet
with SST 18/10 clamp, washable and
exchangeable textile strap, hook-and-loop fastener.



101.0177.1 Body restraint strap
with SST 18/10 attachment elements, washable
and exchangeable, hook-and-loop fasteners,
1,350 mm long, 120 mm wide.

101.0455.1 Body restraint strap
(w/o ill.) as 101.0177.1, but each side 1,000 mm long,
of which 600 mm hook-and-loop zone, 120 mm wide.

General accessories

Model No. Description

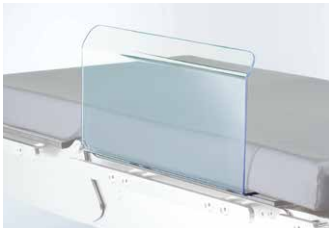

101.0153.0 Arm protector*

comfortable for the OR staff positioned at the side of the OR table, safe protection and anatomically correct positioning of the patient's arm by the protector, which is pushed under the OR table pad and secured by the patient's weight, 400 × 230 × 210 mm (W x D x H).



101.0139.0 Infusion pole

SST 18/10, upper section with 4 hooks, height adjustment range approx. 410 mm, attachment clamp with ball-and-socket joint.



101.0154.0 Tube holder*

for secure positioning of ventilation tubes and monitor cables, helix flexible shaft, height adjustable, with robust plastic plate. Requires attachment clamp 101.0146.0!

Model No. Description



101.0147.0 Attachment clamp*
swivel type, for rods diam. 16 to 20 mm,
SST 18/10.



101.0018.0 Attachment clamp
SST 18/10, swivel type, with quick release and lock,
suitable for poles of 16 to 18 mm diameter.



101.0117.0 Attachment clamp
SST 18/10, non-swivel type, with release and lock,
suitable for square-section poles 20 × 20 mm.



101.0132.0 Attachment clamp
non-swivel type, suitable for poles of 16 to 18 mm
diameter and square-section poles of 10 × 25 mm,
SST 18/10.



101.0146.0 Attachment clamp
swivel type, suitable for poles of
16 to 18 mm diameter, SST 18/10.

General accessories

Model No. Description



101.0010.0 Shoulder support (pair)
incl. 2 clamps 101.0117.0, 2 antistatic pads (120 × 200 mm) and 2 attachment bars to adjust pads horizontally and vertically.



101.0107.1 Lateral support (1 piece)
simple version, including attachment clamp to side rail, smooth antistatic pad (100 × 235 mm).



101.0178.0 Rectoscopy/Buttocks support
adjustable in width, with soft pad, for rectal positioning and spinal surgery.
Requires 2 clamps 101.0146.0 or 101.0147.0!

101.0186.1 Knee/foot rest
for **DIAMOND**® operating tables, for rectal and spinal surgeries with the patient in knee/elbow position, serves also as foot rest for laparoscopic surgery, to be fixed to leg section, including 2 attachment clamps 101.0132.0.

101.2070.1 Knee/foot rest
(w/o ill.) similar to 101.0186.1, but for **mobilis** operating tables.

101.0190.0 Lateral support pad (piece)
(w/o ill.) lateral support of patient, attachment to the knee/foot rest 101.2070.1/101.0186.1 and the knee/foot plates 101.0682.0 by means of clamp (incl.).

Model No. Description



101.0121.0 Bracket for body support
(fig. 1) for attachment of pads 101.0135.0, 101.0151.0, 101.0162.0 and 101.0175.0, allows double swivelling and horizontal as well as vertical adjustment of the supports, includes clamp 101.0117.0.



101.0135.0 Body support roll
(fig. 3) concave foam pad with antistatic cover, 200 × 65 mm.



101.0151.0 Shoulder/lateral support
(fig. 3) concave foam pad with antistatic cover, 215 × 100 mm.



101.0162.0 Back/buttock support
(fig. 4) with antistatic cover, 200 × 120 mm.



101.0175.0 Pubis/sacrum/sternum support
(fig. 5) foam pad, with antistatic cover, 85 × 85 mm.



101.0586.0 Handles (pair)
to be mounted to the head plate, for an easy moving of the operating table.

General accessories

Model No.	Description
-----------	-------------



101.0247.0	<p>Splash protection for DIAMOND® operating tables, transparent plastic cover for the central delivery point at the DIAMOND® table base, serves as splash guard during fluid-intensive interventions, e.g. in urology or obstetrics. Serves to minimise the cleaning effort for DIAMOND® OR tables. Dimensions: 826 × 203 × 250 mm (W x H x D)</p>
-------------------	--



101.0120.0	<p>Rack for accessories SST 18/10 square-section tubular frame with 5 rails for attachment of accessories and 1 basket, antistatic swivel castors, overall dimensions: 630 × 580 × 1,430 mm (W x D x H)</p>
-------------------	--



101.0737.0	<p>Rack for accessories for DIAMOND® operating tables, SST 18/10 square-section tubular frame with 3 pairs of holders for accessories to be attached to the coupling points of the operating table, 5 standard rails for accessories for side rail mounting and 2 baskets for other accessories. 4 double castors, lockable, el. conductive. Total dimensions: 1,135 × 815 × 1,310 mm (W x D x H).</p>
-------------------	--



Model No. Description

101.0622.0 SCHMITZ Integration Module

Module with Bluetooth® technology to connect the **DIAMOND®** OR table to the OR1 central control system for operating theatres by Karl Storz company as of the set-up date 06/2018. Bidirectional data transfer, graphics-supported menu navigation with large, high-resolution colour display for all status information of the table, integrated service and information menu, automatic configuration of all table variants.

Please let our experts advise you.

Attention! The relative **DIAMOND®** operating table absolutely has to feature Bluetooth® preparation 101.0391.1!

For further information on the Bluetooth® functions of the **DIAMOND®** operating table series, please see our catalogue no. 84.

101.0623.0 SCHMITZ Integration Module

(w/o ill.) Same as model 101.0622.0, with open port for connecting to a central control system.



101.0410.0 Rack for storing of head and leg plates

for **DIAMOND®** operating tables, SST 18/10 square-section tubular frame with 6 pairs of mounting devices for head and leg plates as well as shoulder plates and long or short adapter, 2 standard rails and 1 basket.

El. conductive swivel castors.

Total dimensions: 918 × 1,243 × 1,308 mm (W x D x H).

General accessories

Model No. Description



101.0504.0 Cleaning shuttle

for **DIAMOND®** operating tables, device for underchassis cleaning and disinfecting of **DIAMOND®** operating tables. The OR table is moved into the device with the table top raised to a height of 1,060 mm, the frame of the cleaning shuttle is positioned under the seat section of the table. Lowering the table top then lifts the table base off the floor and gives access to its underside for cleaning. SST 18/10 frame, plastic guide rails, 4 antistatic swivel directional castors diam. 75 mm, individually lockable.

516 × 816 × 1,210 mm (W × D × H).

For **DIAMOND®** operating tables as of model year 03/2014.



101.0248.0 Side guards* (pair)

SST 18/10, to safeguard the patient during transportation on the OR table, foldable, incl. clamp. The side guard locks automatically when raised.

615 × 300 mm (L × H).

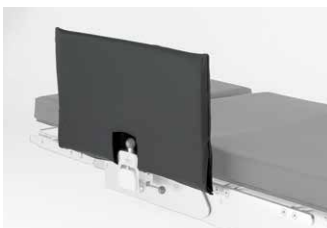

101.0249.0 Pad for side guards*

el. conductive, removable, for side guards 101.0248.0.

Model No.	Description
-----------	-------------



101.0185.0	Leg restraint strap*
-------------------	-----------------------------

	1 pair, with pads, for split leg section, incl. attachment clamps to attach to side rails, length: 1,200 mm.
--	--



101.0218.0	Transfer leg plates
-------------------	----------------------------

	in combination with the attachment device for orthopaedic extension 101.0270.1; also attachment to seat section instead of leg section. Bent SST 18/10 tube with fabric cover, lightweight construction.
--	--

	For anaesthetization of patients for gynaecological or urological interventions or for interventions using the extension device 101.0270.1.
--	---

	Length of leg plates: 875 mm.
--	-------------------------------

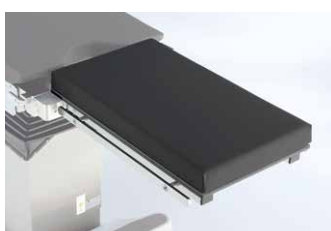

101.0239.0	Plate for paediatric surgery
-------------------	-------------------------------------

	for DIAMOND® operating tables, attachment at the seat section interface, SST 18/10 frame, with side rails for attachment of accessories, visco-elastic foam mattress with electrically conductive cover. Dimensions: 700 x 400 mm (L x W).
--	--

101.0241.0	Plate for paediatric surgery
-------------------	-------------------------------------

(w/o ill.)	
------------	--

	as 101.0239.0,
--	----------------

	however, for mobilis operating tables.
--	--

General accessories C^{MD}

Model No. Description



101.2950.0 CFRP crossbar
for **mobilis** operating tables,
installed at back section, radiolucent.

101.0220.0 Potential equalization cable
(w/o ill.) 3 m long.

101.0230.0 Potential equalization cable
(w/o ill.) 5 m long.



101.0255.0 X-ray cassette holder*
for attachment to side rail, swivelling holder for
positioning an X-ray cassette below the table-top,
incl. clamp.



101.2810.0 Cassette carrier
for **mobilis** operating tables,
for X-ray cassettes of max. 350 × 430 mm,
telescopic insertion bar of SST 18/10.

101.0228.0 Cassette carrier
(w/o ill.) similar to 101.2810.0,
for **DIAMOND**[®] operating tables.

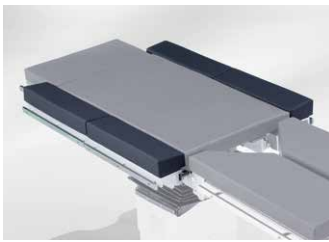

ill. shows 2 sets of
101.0194.0 and
back section extension
101.0131.1

Model No.	Description
-----------	-------------

101.0194.0	Set of extension pads (pair)*
-------------------	--------------------------------------

	set of 2 foam pads with antistatic cover, 500 mm long, for seat and back section, attachment to side rails via quick-locking clamps, with addit. side rails for accessories. For positioning of adipose patients as well as positionings in which patients have to be turned during intervention. New total width of table-top: 790 mm for DIAMOND® and 770 mm for mobilis operating tables.
--	--

101.0200.0	Set of extension pads (pair)*
-------------------	--------------------------------------

(w/o ill.)	similar to extension pads 101.0194.0, but 300 mm long.
------------	--

Note! Required for extension of the DIAMOND® OR table top without back section extension:

- 1 Set of extension pads 101.0194.0, 500 mm long each, for the seat section
- 1 Set of extension pads 101.0200.0, 300 mm long each, for the back section

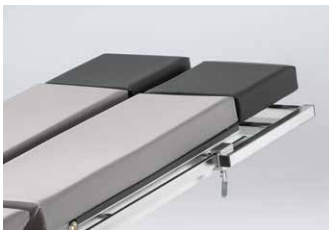

101.0443.0	Table extension (pair)
-------------------	-------------------------------

	cushioned, 255 × 255 mm, for extending the tabletop, attaches to the side rails of the operating table leg plates via integrated clamps.
--	--



101.0368.0	Foot plate (pair)
-------------------	--------------------------

	cushioned, 255 × 255 mm, attaches to the side rails of the operating table leg plates via integrated clamps.
--	--

Accessories for orthopaedics, traumatology, spinal surgery and orthopaedic extension C€MD

Model No. Description



101.0253.0 Shoulder traction device*

System for weightless shoulder suspension, allows for traction settings up to 18.2 kg with a simple turn of the tension adjustment knob. Boom arm adjustable 0° to 90°. Swivel boom head allowing the pulley to align properly with the cord. Fold-down system for easy storage. Incl. clamp for attachment to the side rails of the OR table.

Requires in addition Weinberger hand traction device 101.0163.1.



101.0210.1 Back plate

for **DIAMOND**® 50 and 60 operating table models, for ENT, oral and maxillofacial surgery and ophthalmology, attachment instead of leg plate, with side rails. Requires horseshoe headrest 101.0256.0, alternatively head rest connector 101.0363.0 or fixture 101.0187.0 and horseshoe head rest 101.0179.0.



101.2780.1 Back plate

for **mobilis** operating tables, for ENT, oral and maxillofacial surgery and ophthalmology, attachment instead of leg plate, adjustable with gas spring assistance, with side rails. Requires horseshoe headrest 101.0256.0, alternatively head rest connector 101.0363.0 or fixture 101.0187.0 and horseshoe headrest 101.0179.0.

Model No. Description



101.0015.0 Pad*
for intervertebral disc operations, two-sectional for individual adaptation to the patient's body size, radiolucent, antistatic.
Thoracic cushion 500 × 250 × 200 mm (W x D x H),
pelvic cushion 500 × 340 × 200 mm (W x D x H).



101.0212.0 Knee positioning device*
manually adjustable, with gel pad and fastening strap. Side rail attachment (requires attachment clamp 101.0146.0).



101.0583.0 Knee arthroscopy support*
for side rail attachment, incl. attachment clamp and pads, manual adjustment. The diameter is adjustable by hand crank and adapts also for severely obese patients.



101.0682.0 Knee/foot plates (pair)
for the knee-elbow position during vertebra surgery or proctological procedures and for attachment to the side rails of the leg section; the left and right plate on slide rails can also be moved slightly outwards by 125 mm each even under load; includes mount for side rail.

101.0190.0 Lateral support pad (piece)
(w/o ill.) lateral support of patient, attachment to the knee/foot rest 101.2070.1/101.0186.1 and the knee/foot plates 101.0682.0 by means of clamp (incl.).



Flexible adjustment of the head rest to right and left



Foldable and detachable mattress segments

Accessories for orthopaedics, traumatology, spinal surgery and orthopaedic extension C€MD

Model No. Description



101.0244.1 Shoulder surgery plate
for **DIAMOND®** 50/60 operating table models, for attachment to the electromotive leg section joints, allowing inclination adjustment up to +90°. Free access to the shoulder area thanks to individually fold-down and removable padded segments. Quick removing of segments by pulling a lock pin. Thanks to their hinged attachment to the shoulder surgery plate, the segments can remain at the table during the surgery, eliminating the need of interim storage. Swivelling socket for the head rest joint provides an improved access to the surgical field. 3 positioning options for a lateral body support on both sides of the shoulder surgery plate, incl. 1 lateral body support 101.0612.0 Visco-elastic foam pads with antistatic cover. Requires in addition: head rest connector 101.0364.0 and shaped head rest 101.0266.0.

101.0243.1 Shoulder surgery plate
(w/o ill.) similar to 101.0244.1, for **DIAMOND®** 40 operating table models, manual adjustment of inclination angle up to + 90° with gas spring assistance.

101.0242.0 Shoulder surgery plate
(w/o ill.) similar to 101.0244.1, for **mobilis** operating table models, manual adjustment of inclination angle up to + 90° with gas spring assistance.

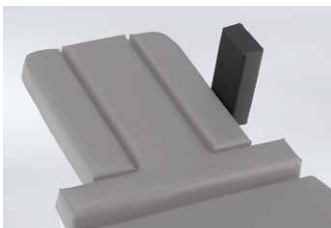

101.0245.0 Lateral body support
SST 18/10, removable visco-elastic pad with antistatic cover. With quick-locking device, release by means of push button. For attachment to shoulder surgery plates 101.0244.1, 101.0243.1 and 101.0242.0.



101.0612.0 Lateral body support, short
Same as model 101.0245.0, but with shorter shelf for positioning slim patients.

Accessories for orthopaedics, traumatology, spinal surgery and orthopaedic extension

Model No. Description



101.0266.0 Shaped head rest for shoulder surgery
U-shaped helmet with soft pads and 2 flexible lateral pads for different head sizes. Safe positioning of the head by means of 2 soft padded straps, hygienic quick-release catch.
Requires head rest connector 101.0364.0 for attachment to the shoulder surgery plate.



101.2790.1 Shoulder arthroscopy plate
for **mobilis** operating tables, attachment instead of leg plate, manual adjustment with gas spring assistance, with individually detachable lateral pads for free access to the shoulders, with side rails. Requires head rest connector 101.0363.0 or 101.0364.0 or fixture 101.0187.0 and shaped head rest 101.0266.0.



101.0108.0 Arm/hand operating table*
radiolucent CFRP board with covered antistatic foam pad, ergonomic shape for optimal access to the surgical field, 815 × 520 mm (W x D).

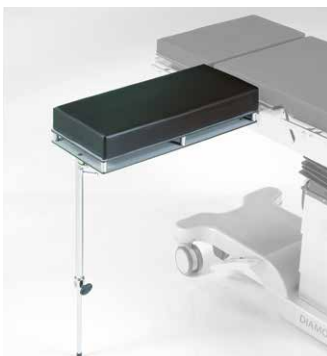

101.0070.1 Arm/hand operating table
radiolucent plastic board with covered foam pad, antistatic, X-ray cassette slot, 700 × 300 mm (W x D).

Model No.	Description
-----------	-------------



101.0163.1	Weinberger hand traction device for intramedullary nailing of the upper arm, vertical rod and horizontal linear guide with accessory rail, adjustable by means of locking ball-and-socket joint, for attachment to the humerus positioning device 101.0136.0 and shoulder traction device 101.0253.0 Hand traction device can be sterilised.
-------------------	---



101.0136.0	Humerus positioning device* for intramedullary nailing of the upper arm, vertical rod and horizontal linear guide with accessory rail, adjustable by means of locking ball-and-socket joint, for attachment of the Weinberger hand traction device 101.0163.1 (to be ordered separately). Requires attachment clamp 101.0146.0.
-------------------	--



101.0152.0	Humerus countertraction post* padded, radiolucent. Requires attachment clamp 101.0146.0.
-------------------	---

Accessories for orthopaedics, traumatology, spinal surgery and orthopaedic extension C€^{MD}

Model No. Description



101.0122.0 Upper arm positioning plate
radiolucent, height adjustment approx. 100 mm by means of clamp, swivels through 90°, foam pad 210 × 260 mm, (W x D).
Requires attachment clamp 101.0117.0.



101.0105.0 Traction unit
for traction of the arm in forearm fractures, incl. attachment clamp. Can only be used in combination with the axilla support 101.0257.0, the elbow support 101.0258.0 and the Weinberger hand traction device 101.0163.1.

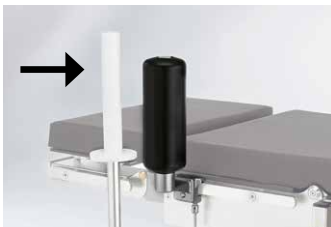

101.0258.0 Elbow support*
for reduction of elbow fractures, incl. clamp. Requires axilla support 101.0257.0, Weinberger hand traction device 101.0163.1 and the traction unit 101.0105.0.



101.0257.0 Axilla support*
padded radiolucent countertraction post, incl. clamp, can only be used in combination with the elbow support 101.0258.0.

Model No. Description



101.0259.0 Leg support*
holds the patient's leg for an easier skin disinfection,
movable foot holder, height adjustable.
Requires clamp 101.0146.0.



101.0261.0 Meniscus positioning device*
radiolucent support roll, flexible positioning of leg
by using swivel-type clamp, requires clamp 101.0146.0.

Carbon Accessories C€^{MD}

Model No.	Description
-----------	-------------



101.7151.1	<p>Carbon plate for DIAMOND[®] operating tables, radiolucent CFRP plate, for mounting to the back section of the OR table. 1,200 mm long. With 60 mm SAF mattress, antistatic, with prop rod. Permissible patient weight: with prop rod 225 kg without prop rod 140 kg</p>
-------------------	---

101.7154.0	<p>Carbon plate (w/o ill.) similar to 101.7151.1, for mobilis operating tables.</p>
-------------------	---

Permissible patient weight:
with prop rod 225 kg
without prop rod 165 kg



101.7152.0	<p>Side rail for carbon plate SST 18/10 side rails 25 × 10 mm, 220 mm long, for attachment to the carbon plates 101.7151.1 and 101.7154.0.</p>
-------------------	---

Model No. Description



101.7200.1 Special arm rest
with radiolucent CFRP plate, attachment to the side rails. 700 × 250 mm, 600 mm of which radiolucent. Swivelling horizontally with interlocking system and handwheel. 25 mm SAF pad, antistatic.



101.7050.1 Special leg plate
for mobilis operating tables, 2-section, with radiolucent CFRP plate, for attachment at seat section. Length: 850 mm, of which 730 mm radiolucent, extendable by 250 mm by means of attachable laminate plates. Width: 2 × 250 mm. Can be loaded with up to 30 kg each. Inclination and spreading by means of interlocking system and clamping levers. 60 mm SAF mattress, antistatic.



DIAMOND® Extension device

Extensions with the SCHMITZ extension device made of carbon or steel – safe, stable and efficient. Every time.

Our extension device is extremely user-friendly and highly versatile.

Patients can be put into difficult positions efficiently thanks to the further improved traction unit with ball clamp and optimised ergonomics.

Even 360° X-rays are no problem with the new carbon extension device. An additional sliding carriage ensures quick, safe positioning.

But it is not only the carriage that benefits from the new carbon bars; a transfer leg plate for anaesthetising patients can also be quickly, individually secured to the extension bar. The extension bars can also be smoothly swivelled out thanks to a new type of wedge clamp.

The shape of the seat section improves access and makes disinfection of the operating environment easier.



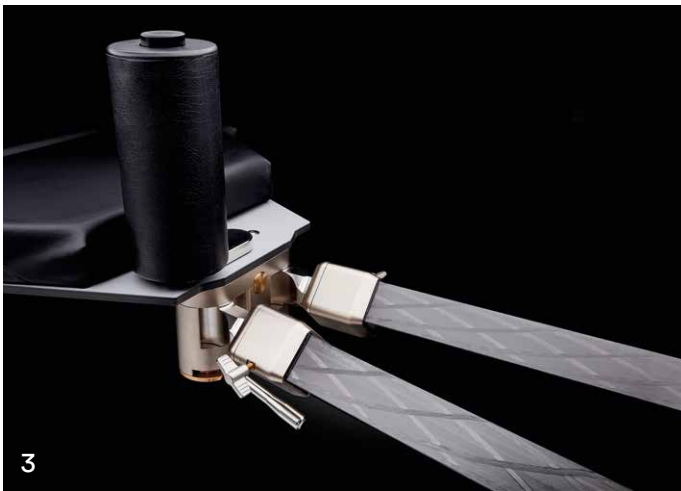

DIAMOND®**The carbon extension device at a glance!**

1

Carriages slide quickly and effortlessly over the bars.

2

Secure positioning of the extended side, even with high traction.
One support on each bar for double stability.

3

Extendable on right or left, simply swap the countertraction post!
Bars swivel out smoothly thanks to the wedge clamp.

4

Carbon extension bars – for 360° X-rays.

5

Premium quality workmanship – made in Germany.

Made in Germany



Hip arthroscopy



Hip arthroscopy



Lower leg fracture

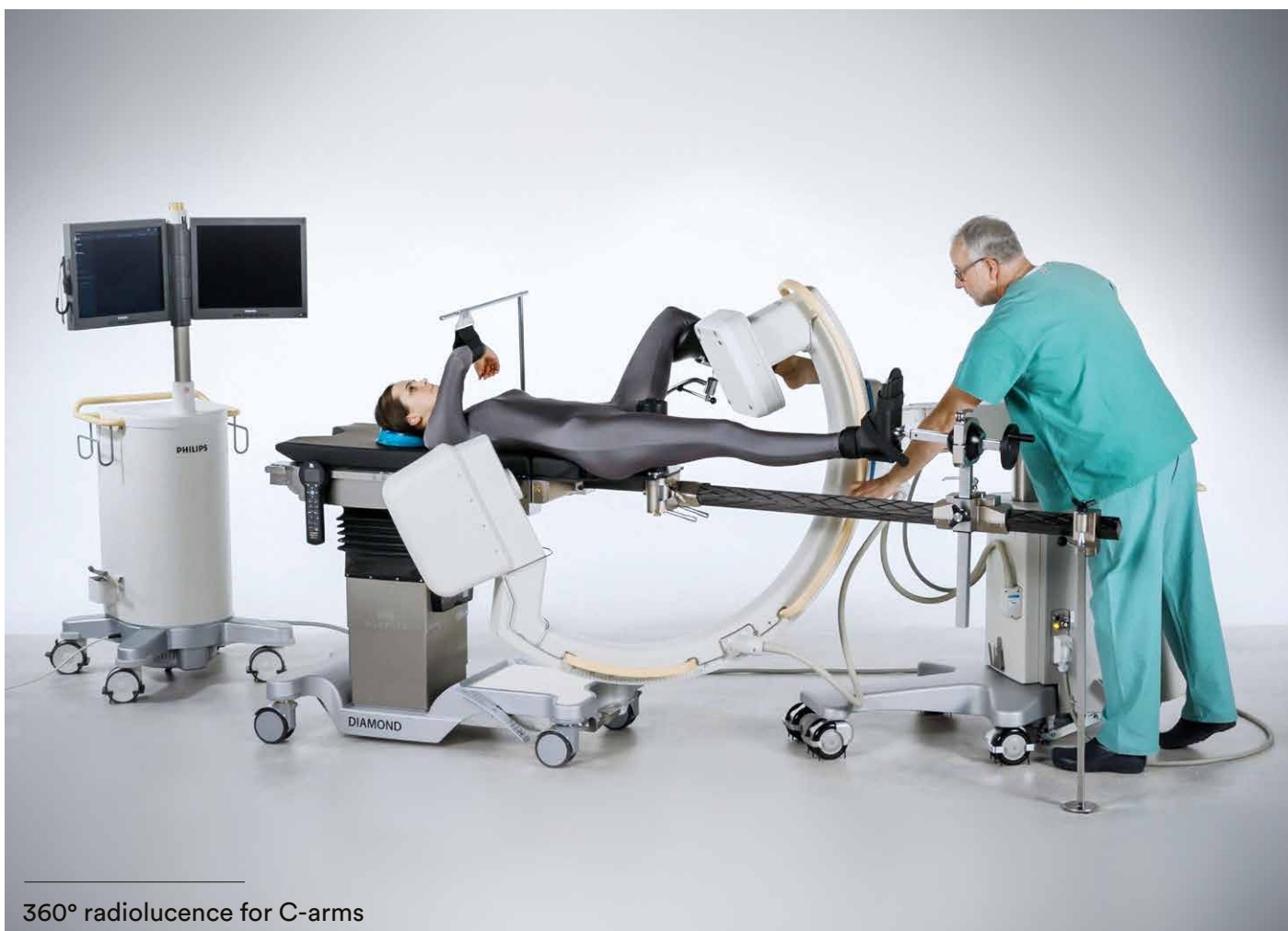

360° radiolucence for C-arms



DIAMOND® Extension device

Model No. Description



101.0563.0 Extension device, carbon
for DIAMOND® operating tables, carbon seat section, with joint for pivoting. With pad, X-ray area of 215 mm and 360° range. Countertraction post with pad, adjustable for right and left extension. Carbon leg bars, 1,250 mm long, 360° X-ray range. Each bar can be expanded 45° outward, 20° inward. Aluminium extension carriage, with mount for traction unit, height-adjustable. Traction unit moves continuously along the bar, adjustable in all directions thanks to the ball joint. Incl. 2 supports on each attachment clamp which can be secured to the bar.

Standard accessories:

- 1 seat section with pad, carbon
- 2 extension bars, carbon
- 2 extension bar supports, SST
- 2 traction boots for adults
- 2 traction units
- 1 adjustable countertraction post for supine position



101.0711.0 Seat section with countertraction post
Design like extension device, carbon 101.0563.0, but consisting of: seat section of extension device, carbon, with pad and countertraction post with pad
Requires extension bar with traction unit 101.0711.0!



101.0712.0 Extension bar with traction unit
Design like extension device, carbon 101.0563.0, but consisting of: one extension bar with traction unit moving along the bar, adjustable in all directions thanks to the ball joint, and one extension bar support, SST. Requires seat section with countertraction post 101.0712.0!



DIAMOND® Extension device

Model No. Description



101.0566.0 **Transport trolley**
Rack for transporting and storing the extension device.



101.0567.0 **Transfer leg plates (pair)**
For positioning the patients' legs during transfer and transport. Secured by aluminium sliding carriage and moves freely along the extension bar. With 60 mm pad.
Length of leg plates: 700 mm
Width of leg plates: 225 mm on each side



101.0704.0 **Transfer leg plate, short (pc.)**
For positioning the patient's legs during transfer and transport. Attachment via integrated mounts at the plate. Attaches to the extension bar mounts of the extension device, carbon.
Can be used on the right or left side.
With carrying handles and 60 mm pad.
700 mm x 225 mm (L x W)

DIAMOND®

Extension device

Model No. Description



101.0568.0 Traction device for tibial fractures
 Height-adjustable and detachable lower leg countertraction post. Can be tilted further thanks to gear ring joint. Slides continuously along extension bar thanks to sliding carriage.



101.0569.0 Condyle fixation
 For fixing the knee precisely, individually adjustable thanks to asymmetrically suspended discs. Can only be used in conjunction with traction device for tibial fractures 101.0568.0 or 101.0280.1.



101.0594.0 Countertraction post for lateral position
 for lateral patient positioning, radiolucent.



101.0595.0 Pelvis plaster adapter with pelvis support

Model No. Description



101.0676.0 Kirschner wire device*
with traction clamp, for use on extensions
with Steinmann pins.



101.0596.0 Side rail extension (1 pc.)
for attachment to the side rail of the operating
table, for attaching a leg holder according
to Göpel 101.0115.0, 490 mm total length =
usable length.



Ball clamping



Extension unit



Max. pull-out extension bar



Degree of extension

The extension device for DIAMOND® and OPX mobilis® in detail

An innovative ball clamping with integrated extension unit assists the operator in the exact adjustment of the surgical site for hip arthroscopy and in the precise repositioning of fractures of the lower extremities.

Clear markers

at the extension device for a safe operation at all times.

Simple fine tuning and intraoperative adjustment

as well as monitoring of the required extension forces are possible at all times thanks to the scaling at the traction mechanism.

Simple and quick mounting

to the operating table by means of the mounting arbor.

Accessories for orthopaedics, traumatology, spinal surgery and orthopaedic extension

For treatment of all kinds of lower limb fractures.

Essential features:

- fast, simple and secure attaching of the device to the DIAMOND® and mobilis operating tables
- modular structure for optimal range of application
- unobstructed access to the lower limbs for X-ray image intensifier and complete transillumination of the two axes
- well-devised accessories for comfortable and precise positioning of the patient
- disinfectant-proof stainless-steel construction



Extension bar
(horizontal or vertical insertion)



Horizontal swivelling
of extension bars



Vertical adjustment of extension bar
when inserted in vertical orientation



Adjustable countertraction post
for dorsal position



Femoral neck fracture



Lower leg fracture

Extension device C€^{MD}

Model No.	Description
101.0270.1	Extension device extension bars with form-locking double joints for swivelling and height adjustment. Joint in the bar can either be adjusted horizontally or vertically for optimal X-ray accessibility. Shiftable traction units mounted on the extension bars; tilting, swivelling and rotation joint. All metal parts are made of electropolished stainless steel 18/10. Complete with basic accessories: <ul style="list-style-type: none">• 1 seat section with pad• 2 extension bar supports,• 2 foot plates for adults,• 2 traction boots for adults,• 1 countertraction post for dorsal position, adjustable



Femoral shaft fractures



Fractures of neck of femur

Extension device

Model No.	Description
101.0748.0 (w/o ill.)	Transport trolley Trolley for transportation and storage of the extension device 101.0270.1, fully mounted.



101.0240.0	Length adaptor for extension device 101.0270.1 SST 18/10, lengthens or shortens the extension bar by 265 mm, allowing an adaptation of the bar to extremely tall or small patients.
-------------------	---

Extension device C€^{MD}

Additional accessories

Model No. Description



101.0340.0 Pelvis plaster adapter with pelvis support
for attachment to the extension device 101.0270.1.



101.0350.0 Countertraction post for lateral position
for attachment to the extension device 101.0270.1,
for lateral patient positioning, radiolucent.



101.0165.0 Kirschner wire device*
for attachment to the extension device 101.0270.1,
for extensions using Steinmann pins.



101.0218.0 Transfer leg plates (pair)
attachment to seat section with mounting for extension
device 101.0270.1, also direct attachment to seat
section instead of leg sections. Bent SST 18/10 tube
with fabric cover, lightweight construction.
For anaesthetization of patients for gynaecological or
urological interventions or for interventions using the
extension device 101.0270.1.
Length of leg plates: 875 mm.

Model No.	Description
-----------	-------------



101.0193.0	Side rail extension (pair) for attachment to the side rail of the operating table, for attaching a leg holder according to Göpel 101.0115.0, 305 mm total length, 200 mm usable length.
-------------------	---



101.0280.1	Traction device for tibial fractures for attachment to the extension device 101.0270.1, countertraction post for lower leg, height adjustable and detachable. Tilttable by means of a gear rim joint.
-------------------	---



101.0569.0	Condyle fixation For fixing the knee precisely, individually adjustable thanks to asymmetrically suspended discs. Can only be used in conjunction with lower leg positioning device 101.0568.0 or 101.0280.1
-------------------	--

101.0201.0	2 foot plates for children (w/o ill.)
-------------------	---

101.0205.0	2 traction boots for children (w/o ill.)
-------------------	--



Extension device C€^{MD}

Additional accessories

Model No. Description

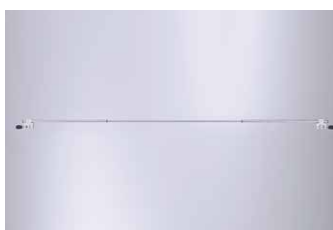

101.0224.0 Telescopic rod*
for suspension of vertical isolation drapes,
mounted to 2 vertical poles by 2 universal clamps,
telescopic rod adjustable from 1,500 to 2,800 mm.



101.0320.0 Pad for hip arthroscopy
for use in hip surgery, to slip onto the
countertraction post. Height 240 mm, diam. 230 mm.

Accessories C€^{MD} for head positioning and neurosurgery

Model No. Description



101.0141.2 Universal adaptor
for **DIAMOND**[®] operating tables, SST 18/10,
for attachment of universal basic unit 101.0142.0
and head rest connector 101.0363.0 or 101.0364.0
or fixture 101.0187.0.

101.2720.0 Universal adaptor
(w/o ill.) similar to 101.0141.2, but for **mobilis** operating tables.



101.0364.0 Head rest connector
with central square mounting, adjustment
by means of handle and ball-and-socket joint,
with side rail adaptor 150 mm long, for attachment
of shaped head rest 101.0266.0 to shoulder surgery
plate 101.0244.1/101.0243.1/101.0242.0 or
shoulder arthroscopy plate 101.2790.1.



101.0363.0 Head rest connector
height adjustable and inclinable side rail adaptor,
200 mm long, suitable for horseshoe head rest
101.0179.0 (requires universal adaptor
101.0141.2 or 101.2720.0).

Model No. Description



101.0187.0 Fixture*
with central square mounting, three-joint adjustment by means of star handles, with side rail adaptor, 275 mm long (requires universal adaptor 101.0141.2 or 101.2720.0).



101.0195.0 Wrist support*
hand support for ophthalmic microsurgery. Height adjustable and reversible. For attachment to fixture 101.0187.0



101.0179.0 Horseshoe head rest*
two-piece, adjustable in width, PU head rest with detachable pad and restraint strap, optimal pressure distribution in prone and supine position. (Requires head rest connector 101.0363.0 or 101.0364.0 or fixture 101.0187.0 and universal adaptor 101.0141.2 or 101.2720.0)



101.0256.0 Horseshoe head rest with one-hand operation*
for positioning the head of patients in prone or supine position, continuous one-hand adjustment, retractable adjustment lever, removable pad, incl. 1 fastening strap (requires universal adaptor 101.0141.2 or 101.2720.0).



Accessories C€^{MD} for head positioning and neurosurgery

Model No.	Description
-----------	-------------



101.0441.1	OMFS plate for DIAMOND ® tables, attachment instead of leg plate, for procedures in the head region (ophthalmology, oral and maxillofacial surgery, ENT), inclinable by gas spring to +/- 40°, head cap featuring double length adjustment for individual adaptation to patient, adjustment range of length presets: 210 mm, adjustment range of fine settings for length: 70 mm, tiltable via ball joint, height adjustable up to 38 mm, detachable shaped headrest.
-------------------	--



101.0503.0	Intermediate pad to support patient's neck when the OMFS plate is extended (from approx. 2/3 pullout).
-------------------	--



101.0501.0	Bolster for e.g. hair transplants, attaches to OMFS plate 101.0441.1 instead of shaped headrest.
-------------------	--



101.0502.0	Side rail adapter for fitting shaped head rest 101.0179.0 to OMFS plate 101.0441.1 instead of shaped headrest.
-------------------	--

Scan the QR code and discover the possibilities offered by the OMFS plate!



Accessories C€^{MD} for head positioning and neurosurgery

Model No. Description



101.0014.0 Cross-bar attachment
SST 18/10, for seated patient positioning in neurosurgery, adjustment for different table widths. Requires 2 clamps 101.0146.0!



101.0142.0 DORO Universal basic unit*
with double-joint adjustment, attachment to adaptor 101.0141.2 or 101.2720.0 or crossbar attachment 101.0014.0. Requires skull clamp adaptor 101.0113.0 and skull clamp 101.0127.0 or shaped head rest 101.156.0.



101.0113.0 DORO Skull Clamp adaptor*
to attach skull clamp 101.0127.0 or shaped head rest 101.0156.0 to universal basic unit 101.0142.0. Upon request, also available in radiolucent material.

Model No.	Description
-----------	-------------



101.0486.0 Radiolucent Headrest System*

for X-raying, visualizing of blood vessels (DSA)
consisting of:

- DORO LUCENT® Base Unit
- DORO LUCENT® Locking Transitional Member
- DORO LUCENT® Transitional Member
- DORO® Swivel Adaptor Radiolucent
- DORO® Skull Clamp Radiolucent
- DORO Lucent® Disposable Skull Pins, Adult (3 pcs.) (not ill.)
- DORO LUCENT® Storage Case (not ill.)

101.0127.0 DORO Skull Clamp*

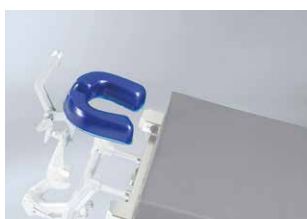
for a secure and stable 3-point fixation of patient's head in supine, prone, lateral or sitting position.
Incl. 1 × 101.0188.0 DORO skull pins (set of 3).
Upon request, also available in radiolucent material.

101.0156.0 DORO Shaped head rest*

double-adjustment, U-shaped gel pads,
requires skull clamp adaptor 101.0113.0 and
basic unit 101.0142.0.

101.0180.0 DORO Skull Pins*

3 pcs. reusable skull pins, paediatric.

101.0188.0 DORO Skull Pins*

3 pcs. reusable skull pins, adult.



Integrated attachment clamp
with cover



The padded extension is used to cover
and protect the head of the fibula
and the peroneal nerve around it.



Leg supports C€^{MD}

Model No. Description



101.0369.0 UniLeg leg supports (pair) with peroneal nerve protection
height-adjustable and spreadable from foot end, with gas spring support, plastic covering with pad for foot and lower leg, adjustable in all positions, with integrated side rail mount.



101.0678.0 UniLeg leg supports (pair)
Same as model 101.0369.0 UniLeg, but **without** peroneal nerve protector.



Accessories €^{MD} for Gynaecology and Urology

Model No.	Description
-----------	-------------



101.0115.0	<p>Leg support (Göpel type) black integral foam pad, antistatic, with fastening strap. SST 18/10, rod of 520 mm length. Requires attachment clamp ref. 101.0018.0 or 101.0146.0.</p>
-------------------	---



101.0219.0	<p>Leg support Göpel type, heavy duty (pair) made of SST 18/10, adjustable by means of comfort joint, freely movable knee crutch can be locked as required, aluminium knee crutch with removable visco-elastic foam pad, incl. fastening strap, adjustable and free movable leg rest shell, aluminium shell with removable viscoelastic pad, incl. strap, rod of 520 mm length. Max admissible patient weight: 250 kg.</p>
-------------------	---

Requires 2 pcs. clamp 101.0147.0

Accessories C€^{MD} for Gynaecology and Urology

Model No. Description



101.0197.1 Adaptor, long
for **DIAMOND**[®] operating tables, to extend the seat section by approx. 420 mm, with cut-out for urological interventions, fully radiolucent, with SST 18/10 side rails 25 × 10 mm and mounting fixtures for leg section. Upon request, also available for tables w/o gyn. cutout.

101.0520.1 Double table top
(w/o ill.) for X-ray cassette insertion, for adaptor, long 101.0197.1.

101.6010.1 Adaptor, long
(w/o ill.) similar to 101.0197.1, but for **mobilis** operating tables.

Note! An additional leg section cannot be attached to the adapter.



101.0204.1 Adaptor, short
for **DIAMOND**[®] operating tables, to extend the seat section by 285 mm, for gynaecological and urological surgery, fully radiolucent, with side rails, cut-out for gynaecology and mounting fixtures for leg section. Upon request, also available for tables w/o gyn. cutout.

101.0530.1 Double table top
(w/o ill.) for X-ray cassette insertion, for Adaptor, short 101.0204.1.

101.4010.1 Adaptor, short
(w/o ill.) similar to 101.0204.1, but for **mobilis** operating tables.

Note! An additional leg section cannot be attached to the adapter.

Model No. Description



101.0170.0 Rinsing basin with holder
for **DIAMOND®** operating tables, SST 18/10,
attachment to table column, with outlet and
plastic hose, dimensions of basin:
350 × 325 × 60 mm (W x D x H).



101.0182.0 Swivel-mounted rinsing basin with holder
SST 18/10 holder and basin, with outlet and
plastic hose, incl. clamp for attachment to side rail.
Dimensions of basin:
350 × 325 × 150 mm (W x D x H).

101.0191.0 TUR sieve
(w/o ill.) SST 18/10, for basins 101.0170.0, 101.0182.0, 101.2470.0
and 101.0362.1.



101.2470.0 Rinsing basin with holder
for **mobilis** operating tables, SST 18/10,
attachment to table column, with outlet and
plastic hose, dimensions of basin:
350 × 325 × 60 mm (W x D x H).



101.0362.1 Rinsing basin with outlet
for **DIAMOND®** operating tables, SST 18/10,
extractable, with outlet and hose, 1,200 mm long.
Attachment to adaptor, short 101.0204.1 or
adaptor, long 101.0197.1.
Dimensions of basin: 350 × 325 × 100 mm (W x D x H).

Accessories C€^{MD} for Gynaecology and Urology

Model No. Description



101.0589.0 Gyn instrument shelf
for DIAMOND® operating tables, for holding instruments during the procedure, inserts into leg section mount of operating table, dimensions of tray 548 × 288 mm.

101.0449.0 Tray for holding gyn. instruments
Replacement tray for inserting in gyn instrument shelf 101.0589.0, dimensions of tray 548 × 288 mm.

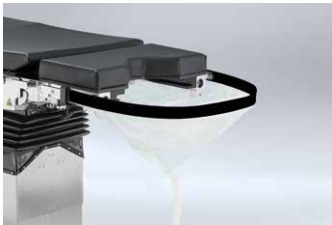

101.0365.0 Fluid Collection System*
for collecting fluids during hysteroscopy or cystoscopy, flexible frame for holding drainage drapes, incl. 10 drapes 101.0499.0 and attachment clamp for securing to the side rails.

101.0499.0 Drainage drapes*
for use with fluid collection system 101.0365.0 (carton w/10 units).



Model No. Description

101.0129.0 Elbow rests (pair)
with SST 18/10 supports for attachment to long adaptor 101.0197.1 or short adaptor 101.0204.1 for **DIAMOND®**, covered foam pads, antistatic, 120 × 200 mm (L x W).
Cannot be used in combination with the basin with gyro flushing 101.0584.1 or the rinsing basin with outlet 101.0362.1.

101.6020.0 Elbow rests (pair)
(w/o ill.) similar to 101.0129.0, but for attachment to long adaptor 101.6010.1 or short adaptor 101.4010.1 for **mobilis**, covered foam.



101.0584.1 Basin with gyro flushing
for attachment to adaptor, short 101.0204.1 or adaptor, long 101.0197.1, large and round SST 18/10 basin Ø 360 mm, extensible, swivel-type, lockable in any position. Without profiled rim for maximum hygiene. Odour sealing by siphon trap at site (wall/floor system). Manual water inlet manually by means of water tap. Highly flexible outlet hose and connecting piece, Ø 40 mm. According to DIN EN 1717.

101.0588.0 TUR sieve
(w/o ill.) round, SST 18/10,
for basin with gyro flushing 101.0584.1.

Positioning aids C€^{MD}

Model No. Description



101.0327.0 Gel pad for lateral positioning*
for safe lateral positioning, to relieve pressure on the shoulder joint and protect the nerve tracts, for surgical interventions on the hip, on the shoulder or on the kidney, 720 × 500 × 160 mm (W x D x H).



101.0328.0 Gel heel pads* (pair)
to support the Achilles area and relieve pressure on the patient's heels during lengthy surgical procedures, 190 × 100 × 70 mm (W x D x H).



101.0329.0 Gel head ring*
open, adult size, provides stability and protection to the patient's face during surgery in lateral position, Ø 200 × 54 mm.

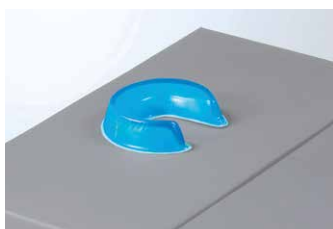

101.0331.0 Gel head ring*
open, paediatric, provides stability and protection to the patient's face during surgery in lateral position, Ø 140 × 34 mm.



101.0332.0 Gel head ring*
closed, adult size, protects the head and ears during surgery in supine position, Ø 200 × 50 mm.

Model No. Description



101.0333.0 Gel head ring*
closed, paediatric, protects the head and ears during surgery in supine position, Ø 140 × 34 mm.



101.0334.0 Gel head rest for prone positioning*
adult size, anatomically designed so that the patient's head can comfortably rest face down, outlets for ET tubes on both sides, 280 × 240 × 140 mm (W x D x H).



101.0335.0 Gel head rest for prone positioning*
paediatric, anatomically designed so that the patient's head can comfortably rest face down, outlets for ET tubes on both sides, 260 × 230 × 135 mm (W x D x H).



101.0336.0 Gel head ring*
closed, for infants, protects the head and ears during surgery in supine position, Ø 90 × 20 mm.



101.0355.0 Gel large prone positioner*
eliminates pressure on the abdomen and facilitates easy ventilation and circulation during long cases in prone position, 1,115 × 520 × 140 mm.

Positioning aids C€^{MD}

Model No. Description



101.0353.0 Gel operating table pad*
1,150 × 520 × 10 mm.

101.0354.0 Gel operating table pad*
(w/o ill.) 1,800 × 520 × 10 mm.

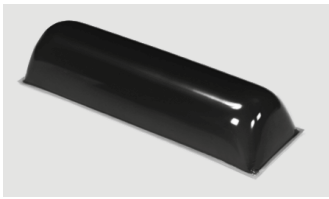

101.0339.0 Gel flat bottom chest roll*
adult size, 505 × 140 × 110 mm.



101.0345.0 Gel universal patient positioner*
150 × 60 × 40 mm.

101.0346.0 Gel universal patient positioner*
330 × 70 × 50 mm.

101.0347.0 Gel universal patient positioner*
290 × 100 × 60 mm.

101.0348.0 Gel universal patient positioner*
345 × 120 × 70 mm.

Model No. Description



101.0343.0 Gel arm retainer pad*
to fit acrylic arm protector 101.0153.0,
157 × 128 × 15 mm.



101.0344.0 Gel sacral protector*
to provide support in the supine and lithotomy
positions, adult size, 450 × 445 × 30 mm.



101.0211.0 Cushion
antistatic covered foam pad, semicircular,
240 × 120 × 475 mm (W x H x L).



101.0208.0 Plexus cushion*
for supine patient positioning, designed to prevent
brachial plexus paralysis and to stabilize the head,
440 × 500 × 100 mm (W x D x H).

Positioning aids

Model No. Description



101.0352.0 Gel lateral leg positioner*
for lateral patient positioning, adult size,
650 × 400 × 230 mm.



101.0341.0 Gel contoured arm board pad*
contoured, adult size, 510 × 155 × 40 mm.



101.0342.0 Gel contoured arm board pad*
(w/o ill.) contoured, for adolescents, 395 × 140 × 40 mm.

101.0337.0 Gel supine head rest*
adult size, ergonomically shaped to position
the patient's head during eye surgery and other
supine procedures, 275 × 237 × 90 mm.

101.0338.0 Gel supine head rest*
(w/o ill.) same as 101.0337.0, for adolescents,
275 × 230 × 65 mm.

Model No. Description



101.0349.0 Gel crutch stirrup pads* (pair)
for Göpel-type leg supports, protect the nerves and blood vessels in the leg during lithotomy procedures, 370 × 205 × 25 mm.



101.0351.0 Gel knee pad*
to protect the knees against pressure damage in the prone position, adult size, 510 × 150 × 40 mm.



Positioning aids

Model No. Description



101.0547.0 Vacuum mattress, lateral position*

Suitable for positioning patients on their side. Optimised pressure relief thanks to MicroSpace filling with virtually untextured surface, including non-slip mat. 2,120 mm x 950/700 mm (L x W).



101.0548.0 Vacuum mattress, standard*

Suitable for all standard procedures in the supine position that require stable patient positioning. Optimised pressure relief thanks to MicroSpace filling with virtually untextured surface, including non-slip mat. 2,000 mm x 750 mm (L x W).

101.0749.0 Vacuum mattress, standard*

(w/o ill.) same as model 101.0548.0, but dimensions 2,000 mm x 1,000 mm (L x W).



101.0549.0 Vacuum mattress, SigmaLap*

Suitable for laparoscopic sigma resections, allows patients to be positioned in a lithotomy position with arms by side and in extreme head-down position. Optimised pressure relief thanks to MicroSpace filling with virtually untextured surface, including non-slip mat. 1,250 mm x 750/1,000 mm (L x W).



DIAMOND® und OPX mobilis® Operating tables C€MD

Overview of accessories

Description	Model No.	Page							Description	Model No.	Page						
			mobilis 200	mobilis 300	mobilis RC 30	mobilis RC 40	DIAMOND® 40	DIAMOND® 50				DIAMOND® 60	mobilis 200	mobilis 300	mobilis RC 30	mobilis RC 40	DIAMOND® 40
Shoulder support (pair)	101.0010.0	28	■	■	■	■	■	■	TUR sieve	101.0191.0	79	■	■	■	■	■	■
Anaesthetic frame	101.0012.0	24	■	■	■	■	■	■	Arm rest	101.0192.0	23	■	■	■	■	■	■
Cross-bar attachment	101.0014.0	72	■	■	■	■	■	■	Side rail extension (pair)	101.0193.0	65	■	■	■	■	■	■
Pad	101.0015.0	37	■	■	■	■	■	■	Set of extension pads	101.0194.0	35	■	■	■	■	■	■
Head plate	101.0017.2	16							Wrist support	101.0195.0	69	■	■	■	■	■	■
Attachment clamp	101.0018.0	27	■	■	■	■	■	■	Adaptor, long	101.0197.1	78						
Arm rest	101.0019.0	23	■	■	■	■	■	■	Set of extension pads	101.0200.0	35	■	■	■	■	■	■
Arm/hand operating table	101.0070.1	40	■	■	■	■	■	■	2 foot plates for children	101.0201.0	65	■	■	■	■	■	■
Traction unit	101.0105.0	42	■	■	■	■	■	■	Adaptor, short	101.0204.1	78						
Lateral support (1 piece)	101.0107.1	28	■	■	■	■	■	■	2 traction boots for children	101.0205.0	65	■	■	■	■	■	■
Arm/hand operating table	101.0108.0	40	■	■	■	■	■	■	Foot control, cable-connected	101.0206.1	13						
Arm rest	101.0109.1	23	■	■	■	■	■	■	Plexus cushion	101.0208.0	85	■	■	■	■	■	■
Anaesthetic frame extension	101.0111.0	24	■	■	■	■	■	■	Back plate	101.0210.1	36						
DORO skull clamp adaptor	101.0113.0	72	■	■	■	■	■	■	Cushion	101.0211.0	85	■	■	■	■	■	■
Leg support (Goepel type)	101.0115.0	77	■	■	■	■	■	■	Knee positioning device	101.0212.0	37	■	■	■	■	■	■
Leg section	101.0116.2	17							Surcharge for 80 mm pads ¹	101.0213.0	-						
Attachment clamp	101.0117.0	27	■	■	■	■	■	■	Hand control unit, Bluetooth®	101.0214.1	12						
Rack for accessories	101.0120.0	30	■	■	■	■	■	■	Foot control, Bluetooth®	101.0216.1	13						
Bracket for body support	101.0121.0	29	■	■	■	■	■	■	Transfer leg plates (pair)	101.0218.0	33+64	■	■	■	■	■	■
Upper arm positioning plate	101.0122.0	42	■	■	■	■	■	■	Leg support Göpel type, heavy duty (pair)	101.0219.0	77	■	■	■	■	■	■
Wristlet	101.0123.0	25	■	■	■	■	■	■	Potential equalization cable	101.0220.0	34	■	■	■	■	■	■
Flexible anaesthetic frame	101.0125.0	25	■	■	■	■	■	■	Telescopic rod	101.0224.0	67	■	■	■	■	■	■
DORO Skull clamp	101.0127.0	73	■	■	■	■	■	■	Return to zero function ¹	101.0225.0	-						
Elbow rests (pair)	101.0129.0	81							Return-to-zero function ¹	101.0226.0	-						
Back section extension, fixed	101.0131.1	16							5th directional castor ¹	101.0227.0	-						
Attachment clamp	101.0132.0	27	■	■	■	■	■	■	Cassette carrier	101.0228.0	34						
Body support roll	101.0135.0	29	■	■	■	■	■	■	Potential equalization cable	101.0230.0	34	■	■	■	■	■	■
Humerus positioning device	101.0136.0	41	■	■	■	■	■	■	Preparation for electr. adj. accessory	101.0238.0	16						
Wristlet	101.0137.0	24	■	■	■	■	■	■	Plate for paediatric surgery DIAMOND®	101.0239.0	33						
Infusion pole	101.0139.0	26	■	■	■	■	■	■	Length adaptor for extension device	101.0240.0	63	■	■	■	■	■	■
Universal adaptor	101.0141.2	68							Plate for paediatric surgery mobilis	101.0241.0	33	■	■	■	■	■	■
DORO Universal basic unit	101.0142.0	72	■	■	■	■	■	■	Shoulder surgery plate	101.0242.0	39	■	■	■	■	■	■
Leg section	101.0145.2	17							Shoulder surgery plate	101.0243.1	39						
Attachment clamp	101.0146.0	27	■	■	■	■	■	■	Shoulder surgery plate	101.0244.1	39						
Attachment clamp	101.0147.0	27	■	■	■	■	■	■	Lateral body support (pc)	101.0245.0	39	■	■	■	■	■	■
Shoulder/lateral support	101.0151.0	29	■	■	■	■	■	■	Splash protection	101.0247.0	30	■	■	■	■	■	■
Humerus countertraction post	101.0152.0	41	■	■	■	■	■	■	Side guards (pair)	101.0248.0	32	■	■	■	■	■	■
Arm protector	101.0153.0	26	■	■	■	■	■	■	Pad for side guards (pc.)	101.0249.0	32	■	■	■	■	■	■
Tube holder	101.0154.0	26	■	■	■	■	■	■	Fastening strap 840 mm	101.0252.0	24	■	■	■	■	■	■
DORO Shaped head rest	101.0156.0	73	■	■	■	■	■	■	Shoulder traction device	101.0253.0	36	■	■	■	■	■	■
Back section extension, inclinable	101.0159.0	16							X-ray cassette holder	101.0255.0	34	■	■	■	■	■	■
Back / buttock support	101.0162.0	29	■	■	■	■	■	■	Horseshoe head rest, one-hand operation	101.0256.0	69	■	■	■	■	■	■
Weinberger hand traction device	101.0163.1	41	■	■	■	■	■	■	Axilla support	101.0257.0	42	■	■	■	■	■	■
Leg restraint strap	101.0164.0	25	■	■	■	■	■	■	Elbow support	101.0258.0	42	■	■	■	■	■	■
Kirschner wire device	101.0165.0	64	■	■	■	■	■	■	Leg support	101.0259.0	43	■	■	■	■	■	■
Rinsing basin with holder	101.0170.0	79							Meniscus positioning device	101.0261.0	43	■	■	■	■	■	■
Leg section, four-part	101.0171.1	21							Fastening strap 1,400 mm	101.0262.0	24	■	■	■	■	■	■
Pubis/Sacrum/Sternum support	101.0175.0	29	■	■	■	■	■	■	Shaped head rest for shoulder surgery	101.0266.0	40	■	■	■	■	■	■
Body restraint strap	101.0177.1	25	■	■	■	■	■	■	Extension device	101.0270.1	61	■	■	■	■	■	■
Rectoscopy/buttocks support	101.0178.0	28	■	■	■	■	■	■	Traction device for tibial fractures	101.0280.1	65	■	■	■	■	■	■
Horseshoe head rest	101.0179.0	69	■	■	■	■	■	■	Pad for hip arthroscopy	101.0320.0	67	■	■	■	■	■	■
DORO skull pins	101.0180.0	73	■	■	■	■	■	■	Gel pad for lateral positioning	101.0327.0	82	■	■	■	■	■	■
Swivel-mounted rinsing basin with holder	101.0182.0	79							Gel heel pads (pair)	101.0328.0	82	■	■	■	■	■	■
Leg restraint strap	101.0185.0	33	■	■	■	■	■	■	Gel head ring	101.0329.0	82	■	■	■	■	■	■
Knee/foot rest	101.0186.1	28							Gel head ring	101.0331.0	82	■	■	■	■	■	■
Fixture	101.0187.0	69	■	■	■	■	■	■	Gel head ring	101.0332.0	82	■	■	■	■	■	■
DORO skull pins	101.0188.0	73	■	■	■	■	■	■	Gel head ring	101.0333.0	83	■	■	■	■	■	■
Lateral support pad (piece)	101.0190.0	28+37	■	■	■	■	■	■	Gel prone head rest	101.0334.0	83	■	■	■	■	■	■

¹ These items can be found in the main catalogues for DIAMOND® and OPX mobilis® OR table series.



DIAMOND® und OPX mobilis® Operating tables C€^{MD}

Overview of accessories

Description	Model No.	Page							Description	Model No.	Page						
			mobilis 200	mobilis 300	mobilis RC 30	mobilis RC 40	DIAMOND® 40	DIAMOND® 50				DIAMOND® 60	mobilis 200	mobilis 300	mobilis RC 30	mobilis RC 40	DIAMOND® 40
Gel prone head rest	101.0335.0	83	■	■	■	■	■	■	Extension device, carbon	101.0563.0	53				■	■	■
Gel head ring	101.0336.0	83	■	■	■	■	■	■	Transport trolley	101.0566.0	55				■	■	■
Gel supine head rest	101.0337.0	86	■	■	■	■	■	■	Transfer leg plates (pair)	101.0567.0	55				■	■	■
Gel supine head rest	101.0338.0	86	■	■	■	■	■	■	Lower leg positioning device	101.0568.0	56				■	■	■
Gel flat bottom chest roll	101.0339.0	84	■	■	■	■	■	■	Condyle fixation	101.0569.0	56+65	■	■	■	■	■	■
Pelvis plaster adapter with pelvis support	101.0340.0	64	■	■	■	■	■	■	Universal leg plate	101.0572.0	20				■	■	■
Gel contoured arm board pad	101.0341.0	86	■	■	■	■	■	■	Emergency control mobilis RC 30 ¹	101.0573.0	-			■			
Gel contoured arm board pad	101.0342.0	86	■	■	■	■	■	■	Emergency control mobilis RC 40 ¹	101.0574.0	-				■		
Gel arm retainer pad	101.0343.0	85	■	■	■	■	■	■	Double table top for 101.0159.0	101.0580.0	16				■	■	■
Gel sacral protector	101.0344.0	85	■	■	■	■	■	■	Knee arthroscopy support	101.0583.0	37	■	■	■	■	■	■
Gel universal patient positioner	101.0345.0	84	■	■	■	■	■	■	Basin with gyro flushing	101.0584.1	81				■	■	■
Gel universal patient positioner	101.0346.0	84	■	■	■	■	■	■	Handles (pair)	101.0586.0	29	■	■	■	■	■	■
Gel universal patient positioner	101.0347.0	84	■	■	■	■	■	■	TUR Sieve	101.0588.0	81				■	■	■
Gel universal patient positioner	101.0348.0	84	■	■	■	■	■	■	Gyn instrument shelf	101.0589.0	80				■	■	■
Gel crutch stirrup pads (pair)	101.0349.0	87	■	■	■	■	■	■	Hand control unit, cable-connected	101.0590.1	12				■		
Countertraction post for lateral position	101.0350.0	64	■	■	■	■	■	■	Hand control unit, Bluetooth®	101.0591.1	12				■		
Gel knee pad	101.0351.0	87	■	■	■	■	■	■	Countertraction post for lateral position	101.0594.0	56				■	■	■
Gel lateral leg positioner	101.0352.0	86	■	■	■	■	■	■	Pelvis plaster adapter with pelvis support	101.0595.0	56				■	■	■
Gel operating table pad	101.0353.0	84	■	■	■	■	■	■	Side rail extension	101.0596.0	57				■	■	■
Gel operating table pad	101.0354.0	84	■	■	■	■	■	■	Lateral body support (pc)	101.0612.0	39	■	■	■	■	■	■
Gel prone positioner, large	101.0355.0	83	■	■	■	■	■	■	Leg section, light version	101.0621.0	17				■	■	■
Charging cradle, pedestal version	101.0356.0	15							SCHMITZ Integration Module	101.0622.0	31				■	■	■
Charging cradle, wall mount version	101.0357.0	15							SCHMITZ Integration Module	101.0623.0	31				■	■	■
Charging cradle, rail-mount version	101.0358.0	15							Leg restraint strap	101.0625.0	25	■	■	■	■	■	■
Foot control, cable-connected	101.0359.0	13							Kirschner wire device	101.0676.0	57				■	■	■
Foot control, Bluetooth®	101.0360.0	13							UniLeg leg supports (pair)	101.0678.0	75	■	■	■	■	■	■
Rinsing basin with outlet	101.0362.1	79							Knee/ foot plates (pair)	101.0682.0	37	■	■	■	■	■	■
Head rest connector	101.0363.0	68	■	■	■	■	■	■	Back section extension, short	101.0689.0	17				■	■	■
Head rest connector	101.0364.0	68	■	■	■	■	■	■	Double table top for 101.0689.0	101.0690.0	17				■	■	■
Fluid Collection System	101.0365.0	80	■	■	■	■	■	■	Transfer leg plate, short (piece)	101.0704.0	55				■	■	■
Foot plate (pair)	101.0368.0	35	■	■	■	■	■	■	Seat section with countertraction post	101.0711.0	53				■	■	■
UniLeg leg supports (pair)	101.0369.0	75	■	■	■	■	■	■	Extension bar with traction unit	101.0712.0	53				■	■	■
with peroneal nerve protection									Rack for accessories	101.0737.0	30				■	■	■
Hand control unit, cable-connected	101.0380.1	12							Transport trolley	101.0748.0	63	■	■	■	■	■	■
Bluetooth® preparation	101.0391.1	13							Vacuum mattress, standard	101.0749.0	89	■	■	■	■	■	■
Preparation, cable-connected foot control	101.0397.0	13							Knee/ foot rest	101.2070.1	28	■	■	■	■		
Rack for storing of head and leg plates	101.0410.0	31							2 Section leg section (pair)	101.2170.1	22	■	■	■	■		
Double table top ¹	101.0430.0	-							Leg section	101.2180.1	22	■	■	■	■		
OMFS plate	101.0441.1	71							Rinsing basin with holder	101.2470.0	79	■	■	■	■		
Table extension (pair)	101.0443.0	35	■	■	■	■	■	■	Head rest	101.2580.1	22	■	■	■	■		
Tray for holding gyn instruments	101.0449.0	80							Head rest	101.2590.1	22	■	■	■	■		
Body restraint strap	101.0455.1	25	■	■	■	■	■	■	Universal adaptor	101.2720.0	68	■	■	■	■		
Double table top for 101.0017.2	101.0480.0	16							Back plate	101.2780.1	36	■	■	■	■		
Radiolucent Headrest System	101.0486.0	73	■	■	■	■	■	■	Shoulder arthroscopy plate	101.2790.1	40	■	■	■	■		
Double table top for 101.0145.2	101.0490.0	17							Cassette carrier	101.2810.0	34	■	■	■	■		
Drainage drapes	101.0499.0	80	■	■	■	■	■	■	CFRP crossbar	101.2950.0	34	■	■	■	■		
Double table top for 101.0116.2	101.0500.0	17							Adaptor, short	101.4010.1	78	■	■	■	■		
Bolster	101.0501.0	71							Adaptor, long	101.6010.1	78	■	■	■	■		
Side rail adapter	101.0502.0	71							Elbow rests (pair)	101.6020.0	81	■	■	■	■		
Intermediate pad	101.0503.0	71							Special leg plates	101.7050.1	45	■	■	■	■		
Cleaning shuttle DIAMOND®	101.0504.0	32							Carbon plate for DIAMOND®	101.7151.1	44				■	■	■
Double table top for 101.0131.1	101.0510.1	16							Side rail for carbon plate	101.7152.0	44	■	■	■	■	■	■
Double table top for 101.0197.1	101.0520.1	78							Carbon plate for mobilis	101.7154.0	44	■	■	■	■		
Double table top for 101.0204.1	101.0530.1	78							Special arm rest	101.7200.1	45	■	■	■	■	■	■
Double table top for 101.0171.1	101.0540.0	21															
Vacuum mattress lateral position	101.0547.0	89	■	■	■	■	■	■									
Vacuum mattress, standard	101.0548.0	89	■	■	■	■	■	■									
Vacuum mattress, SigmaLap	101.0549.0	89	■	■	■	■	■	■									

¹ These items can be found in the main catalogues for DIAMOND® and OPX mobilis® OR table series.



Contact

SCHMITZ u. Söhne
GmbH & Co. KG
Zum Ostenfeld 29
58739 Wickede (Ruhr)

P. O. Box 14 61
58734 Wickede (Ruhr)
Germany

T +49 (0)2377 84 0
F +49 (0)2377 84 162
zentrale@schmitz-soehne.de

Exports department:
T +49 (0)2377 84 0
F +49 (0)2377 84 135
export@schmitz-soehne.de

Technical service, hotline:
T +49 (0)2377 84 549
F +49 (0)2377 84 210
service@schmitz-soehne.de

Information on our
establishments worldwide
can be found
on our website:

www.schmitz-soehne.com



All devices marked with the CE-MD symbol, in combination with our accessories, meet the requirements of Medical Device Regulation 2017/745/EU (MDR) as well as the Medical Device Amendment Act and are risk class I medical devices.



All devices marked with the simple CE symbol meet the requirements of low-voltage directive 2014/35/EU as well as the regulation on electrical equipment.

Please also refer to the instructions for use, for more details about the intended use!



* This product is an article of merchandise, sold under OEM brand name.

Our goods and services are to be understood ex works. Deliveries are effected via our authorized partners or branch offices. The company reserves the right to alter the design, construction, dimensions and finish of its products without notice. All relevant dimensions and weights are to be understood as approximate information/ data. Due to technical reasons colour deviations are possible. The patient positionings shown in this catalogue are only exemplary and make no claim to the correctness and/or completeness of the accessories, please observe the instructions for use in any case.

The articles shown in this catalogue are not authorized for sale in the United States.

Nominal charge 3.00 Euro.

SCHMITZ-Catalogue No. 92, 01.2023 GB